

TWO PARTS

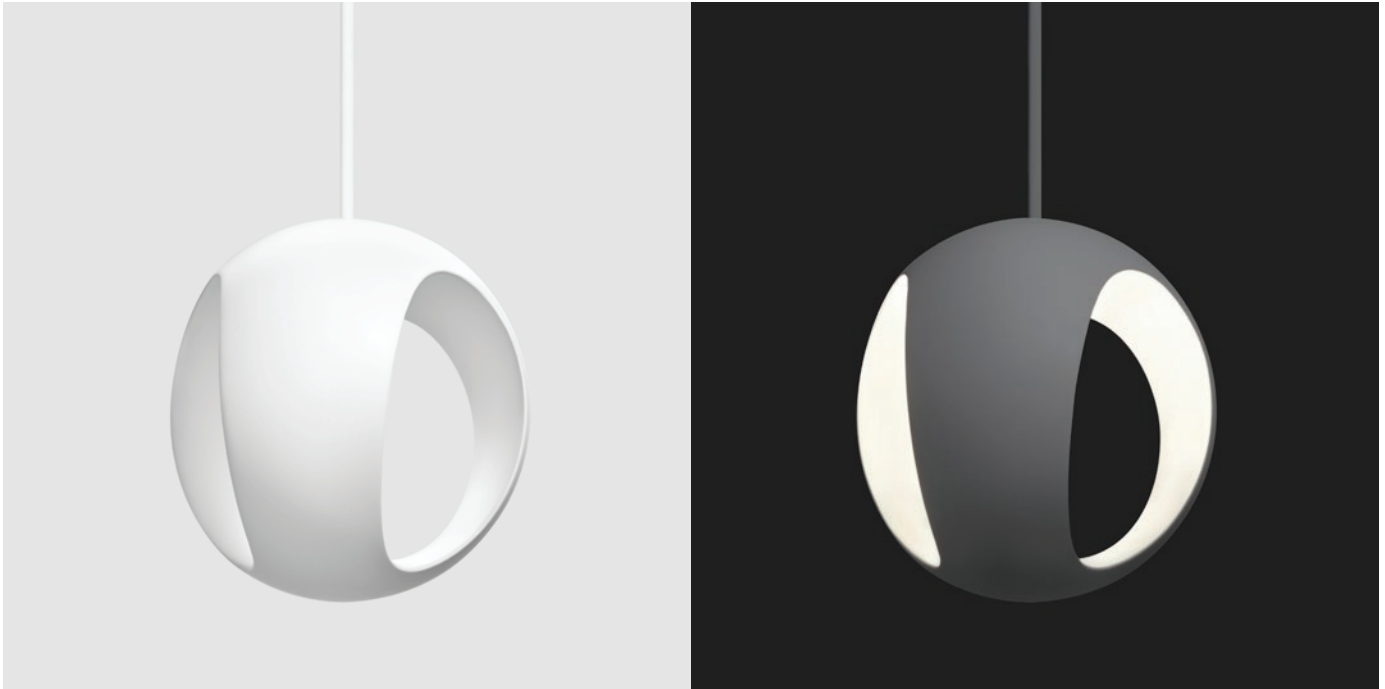

Hydrogen

By Christo Logan

Description

Indoor Pendant Fixture

Fixture

Material: Resin
Color: Matte White
Dims: 6.6 x 6.1 x 6.8 in
Dims: 168 x 155 x 172 mm

Cord

Color: White
Length: 20 ft / 6 m

Driver

Fits in most Junction Boxes
Dimming: Triac, ELV, 0-10V
Input Voltage: 100-305V AC

LED

Input: 5.5W
Output: 450 lm
User replaceable: No
Life Expectancy: 50,000 hours
Color Accuracy: CRI 95+, R9 90+
Input: 12V Constant Voltage

Warranty

Fixture: 5 years
Driver: 3 years

Certification

ETL Listed (UL + CSA Standards)
Damp Location
CE, RoHS

Download CAD, Revit, IES

<http://two.parts/hydrogen>

Light Temp

- HYD-WW-27 : 2700K
- HYD-WW-30 : 3000K
- HYD-WW-35 : 3500K

Cluster Size + Driver

- 1 : 10W Driver
- 2 : 25W Driver
- 3 : 25W Driver
- 4 : 25W Driver
- 5 : 40W Driver
- 6 : 40W Driver
- 7 : 40W Driver

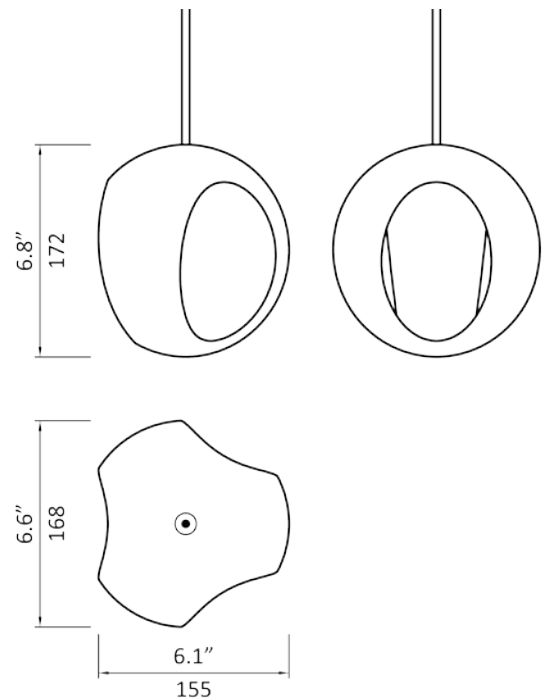

TWO PARTS

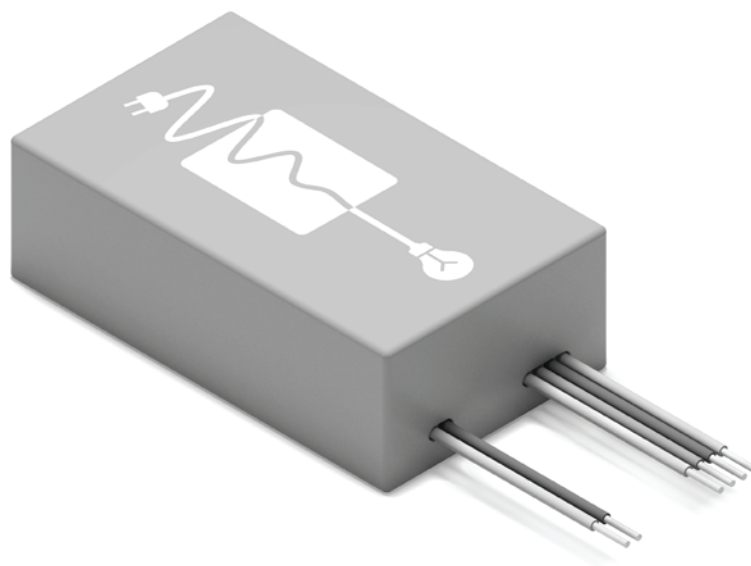

Driver 10W

By LTF LLC

Part No

D10W12V-UI-UD

Description

Dimmable Low Voltage LED Driver

Manufacturer Part

LTF DS10W12VMB1UD

Features

Fits in most Junction Boxes
Auto-reset, Short Circuit, Overload
and Thermal Protection

Warranty

3 year limited warranty

Input

Voltage: 100-305V AC
Frequency: 50/60Hz

Output

Type: Constant Voltage
Power: 10W
Voltage: 12V DC
Current: 833mA

Specs

Dimming: Triac, ELV, 0-10V
Class: Class 2 Power Supply
IP Rating: IP67
Humidity: 95% RH Max

Certification

UL8750, UL1310
CE, RoHS
FCC Part 15 Class B Compliant

Dimensions

2.7 x 1.6 x 0.9 in
68 x 40 x 22 mm

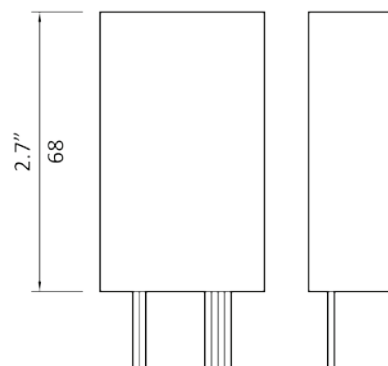
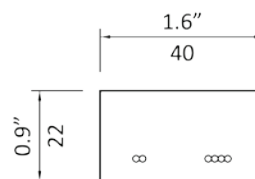

TWO PARTS

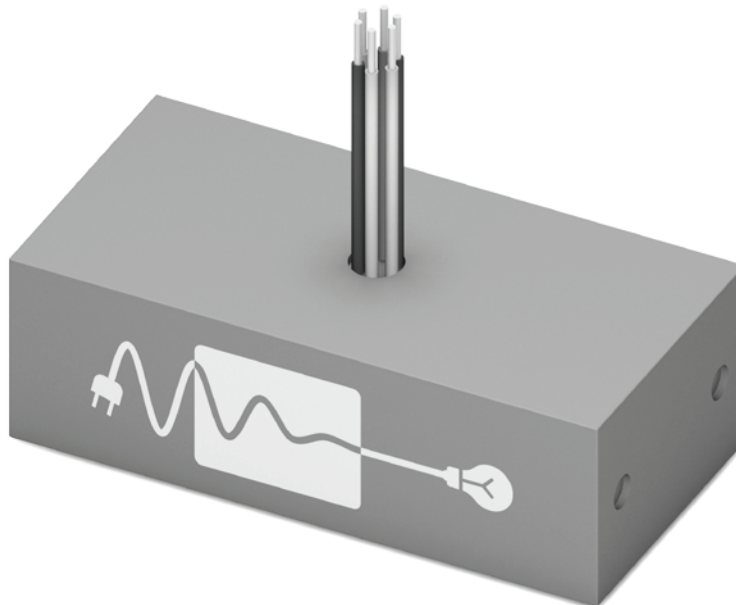

Driver 25W

By LTF LLC

Part No

D25W12V-UI-UD

Description

Dimmable Low Voltage LED Driver

Manufacturer Part

LTF DS25W12VBF1UD

Features

Fits in most Junction Boxes
Auto-reset, Short Circuit, Overload
and Thermal Protection

Warranty

3 year limited warranty

Input

Voltage: 100-305V AC
Frequency: 50/60Hz

Output

Type: Constant Voltage
Power: 25W
Voltage: 12V DC
Current: 2083mA

Specs

Dimming: Triac, ELV, 0-10V
Class: Class 2 Power Supply
IP Rating: IP67
Humidity: 95% RH Max

Certification

UL8750, UL1310
CE, RoHS
FCC Part 15 Class B Compliant

Dimensions

3.1 x 1.5 x 1.0 in
78 x 38 x 26 mm

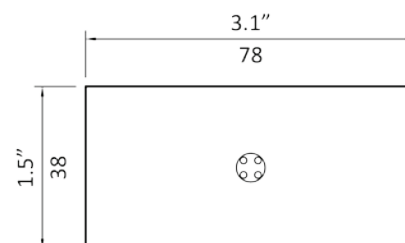

TWO PARTS

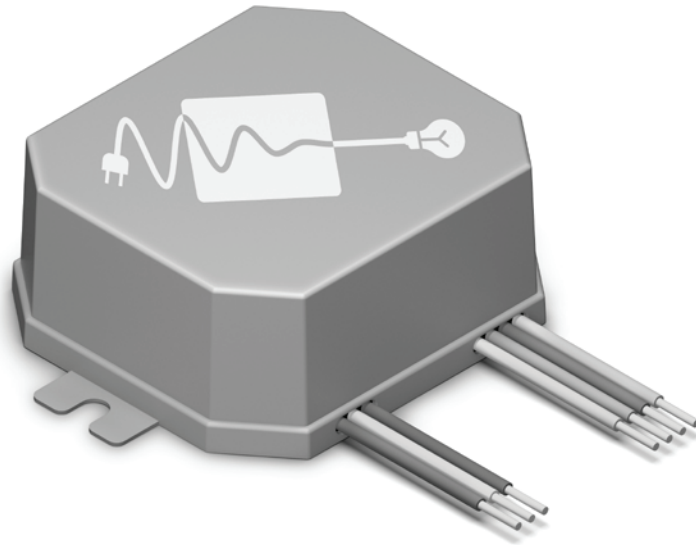

Driver 40W

By LTF LLC

Part No

D40W12V-UI-UD

Description

Dimmable Low Voltage LED Driver

Manufacturer Part

LTF DS40W12VOCUD

Features

Fits in most Junction Boxes
Auto-reset, Short Circuit, Overload
and Thermal Protection

Warranty

3 year limited warranty

Input

Voltage: 100-305V AC
Frequency: 50/60Hz

Output

Type: Constant Voltage
Power: 40W
Voltage: 12V DC
Current: 3333mA

Specs

Dimming: Triac, ELV, 0-10V
Class: Class 2 Power Supply
IP Rating: IP67
Humidity: 95% RH Max

Certification

UL8750, UL1310
CE, RoHS
FCC Part 15 Class B Compliant

Dimensions

3.5 x 2.5 x 1.2 in
90 x 63 x 30 mm

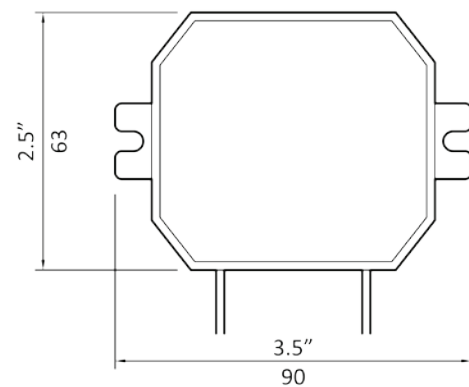
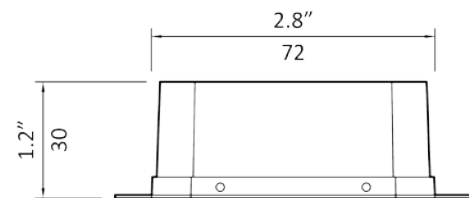

TWO PARTS

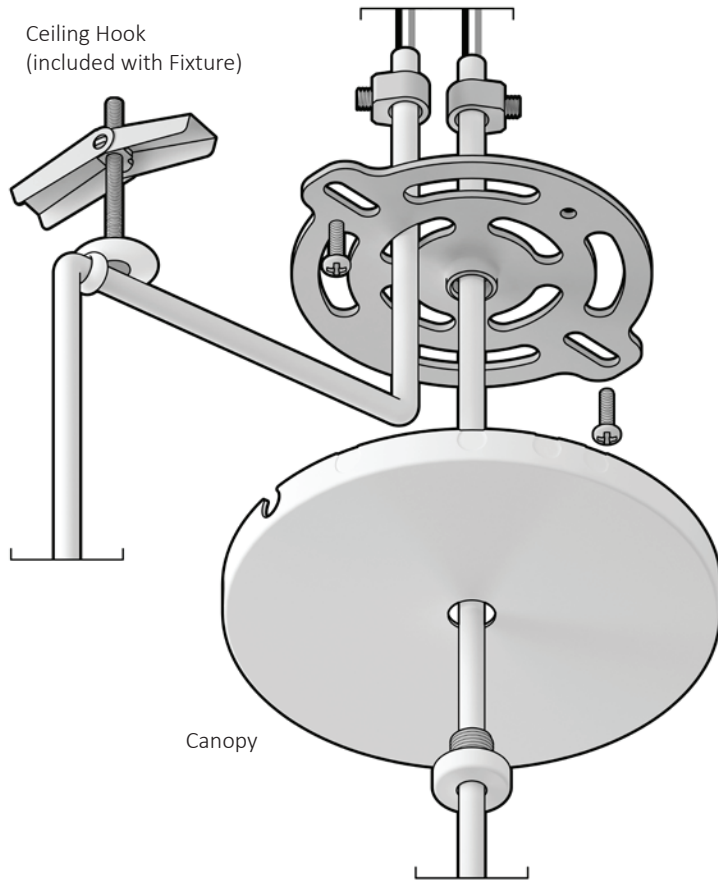

Canopy01

By Christo Logan

Part No

C01-W-7P

Canopy

Fixtures Supported: 1- 7

Material: Steel

Color: White

Dims: $\varnothing 4 \frac{1}{2} \times H3/8$ in

Dims: $\varnothing 115 \times H9$ mm

Features

Low Profile

No exposed screws

Side port knockouts

Center port cap

Ceiling Hook

Included with Fixture

Screw size: #8 or M4 flathead

Material: Steel

Color: White

Dims: $\varnothing 0.8 \times H0.4$ in

Dims: $\varnothing 20 \times H11$ mm

Certification

ETL Listed (UL & CSA Standards)

Damp Location

CE, RoHS

Download CAD, Revit, IES

<http://two.parts/canopy01>

Center & Side Mounted



1



2



3

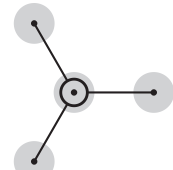

4

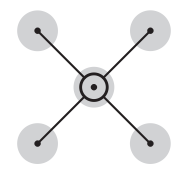

5

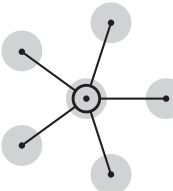

6

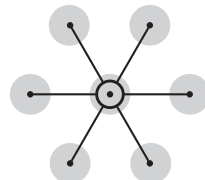

7 Fixtures

Side Mounted Only

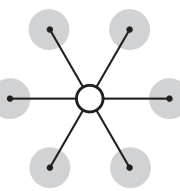
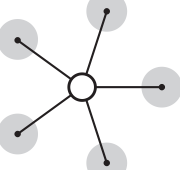
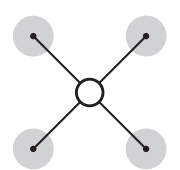
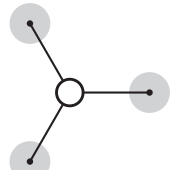
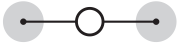
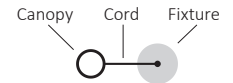

TWO PARTS

Circuit Connector
(customer provided)
Must be UL/CSA/CE approved (US/Canada/
Europe) for applicable wire gauge

LED Driver
To be housed in accessible location
as near as possible to Fixture.

Circuit Connector
(customer provided)
Must be UL/CSA/CE approved
(US/Canada/Europe) for
applicable wire gauge

Anchor
Hole Ø: 9/16" or 15mm

Ceiling Hook
Use #8 or M4 flathead
screw located 1/2" or
13mm shy of fixture
location

Cord
Side Mounted

Side Port Knockout

Building Wires
(customer provided)

Internal Wires
Black+ White-
Multiple Fixtures to be wired
in parallel to a single Driver

Cord Grip

Crossbar

Screw
(customer provided)

Canopy

Center Port

Canopy Screw

Cord
Center Mounted

INSTALL GUIDE

All components are included
unless otherwise noted.

WARNING

Electric shock risk. Use caution
when installing. Turn off
electrical power at breaker
before installation. Installation
should be performed by a
qualified electrician only.

The installer must ensure that
the ceiling can support fixture's
weight and reinforce ceiling
structure by adequate means if
necessary.

MAINTENANCE

Wipe exposed surfaces with
dry cloth as needed.

INSTRUCTIONS

1A Center Mount Remove cap
from Canopy Screw.

1B Side Mount Install Ceiling
Hook(s) with loop facing away
from canopy. Knock out side
port(s) according to cluster
configuration.

2 Cut each Cord to desired
length, leaving 3" (70mm) of
exposed Internal Wires.

3A Center Mount Thread
Cord through Canopy Screw,
Canopy, Crossbar and Cord
Grip.

3B Side Mount Thread Cord
through Ceiling Hook, Crossbar
and Cord Grip.

4 Secure Cord Grip onto each
Cord with 1/2" (10mm) of Cord
left above.

5 Using Circuit Connectors
appropriate to local building
code, connect Internal Wires
to Driver and connect Driver to
Building Wires.

6 Screw Crossbar to ceiling or
outlet box.

7 Affix Canopy Screw to
Crossbar with Canopy in
between.